

Summary Report

Industrial Applications of Basic CAD (on AutoCAD Software)

18th, 19th & 22nd September, 2012

Organised by



ESTD - 1999

Department of Mechanical Engineering
Sankalchand Patel College of Engineering
Visnagar



In association with
Mr. Jayesh Mehta
Experts



Mr. Jignesh Prajapati
AUTODESK Certified Instructor

Mr. Utpal Patel
AUTODESK Certified Instructor

Prof. D S Patel (Associate Professor)

Coordinator

Dr. H. N. Shah (Principal)

Patron

Prof. B. D. Patel (Assistant Professor)

Co- Coordinator

Shri B. C. Patel

Chairman-NSVKM

Workshop Contents

Day-1	10.00 am to 10.30	Inauguration
	10.30 am to 12.30 pm	Introduction- AutoCAD Software and Basic Commands
	1.15 pm to 3.15 pm	Lecture on CAD (Live Demonstration)
	3.30 pm to 5.00 pm	Practice session on 2D Drawing
Day-2	10.00 am to 12.30 pm	Lecture on Drawing and Editing
	1.15 pm to 3.15 pm	Practice session- Object Properties, Dimensioning / Text
	3.30 pm to 5.00 pm	Practice session- Hatch & Patterns
Day-3	10.00 am to 12.30 pm	Lecture on 3D Drawing & Assembly
	1.15 pm to 3.15 pm	Practice Session- 3D Drawing ,Managing Drawing ,Layout, Print
	3.30 pm to 4.45 pm	Advanced CAD - Industrial Application
	4.45 pm to 5.15 pm	Valedictory

Participants



Registered Participants

PATEL RAVIKUMAR KANUBHAI	3 rd Mech. Engg.
PATEL SUHAGKUMAR HARSHADBHAI	3 rd Mech. Engg.
PATEL AJAYKUMAR MAHENDRABHAI	3 rd Mech. Engg.
PATEL NIKUNJKUMAR KANUBHAI	3 rd Mech. Engg.
PATEL CHINTAN DILIPKUMAR	3 rd Mech. Engg.
PATEL JAIMIN PRAVINBHAI	3 rd Mech. Engg.
PATEL KINJANKUMAR VISHNUBHAI	3 rd Mech. Engg.
PATEL PARTHKUMAR ROHITKUMAR	3 rd Mech. Engg.
JAYSWAL VICKY RAMESHBHAI	3 rd Mech. Engg.
PATEL KEVIN ARVINDBHAI	3 rd Mech. Engg.
PRAJAPATI KIRANKUMAR DAHYABHAI	3 rd Mech. Engg.
GANDHI VIVEK GHANSHYAMBHAI	3 rd Mech. Engg.
PATEL PIYUSHKUMAR RAMABHAI	3 rd Mech. Engg.
PATEL RAVINDRAKUMAR KALABHAI	3 rd Mech. Engg.
PATEL BRIJESHKUMAR HASMUKHBHAI	3 rd Mech. Engg.
PATEL ARPIT ARVINDKUMAR	3 rd Mech. Engg.
PATEL KUSH DASHRATHBHAI	3 rd Mech. Engg.

MALEKPURA SHABBIALI GULAMALI	3 rd Mech. Engg.
DAVE SANKET HEMENDRAKUMAR	3 rd Mech. Engg.
PATEL YASHKUMAR GAJENDRABHAI	3 rd Mech. Engg.
PATEL PARTH ANILKUMAR	3 rd Mech. Engg.
PATEL PARASKUMAR VISHNUBHAI	3 rd Mech. Engg.
GUPTA ABHISHEKKUMAR MANOJKUMAR	3 rd Mech. Engg.
PATEL SHREYASKUMAR JAYANTILAL	3 rd Mech. Engg.
SHAH PRADIPKUMAR SHOBHAGAMAL	3 rd Mech. Engg.
PATEL AKSHAYKUMAR DASHRATHBHAI	3 rd Mech. Engg.
PATEL MITEN CHHANABHAI	3 rd Mech. Engg.
PATEL SUKESHKUMAR BHARATBHAI	3 rd Mech. Engg.
RABADI MAHMADRAJA AIYUBBHAI	3 rd Mech. Engg.
PATEL AJAYKUMAR PRABHUDAS	3 rd Mech. Engg.
PUROHIT HARDIK NALINCHANDRA	3 rd Mech. Engg.
CHAUDHARI AKASH SURESHBHAI	3 rd Mech. Engg.
PATEL SIDDHARTHKUMAR ASHWINBHAI	3 rd Mech. Engg.

PATEL DEEPKUMAR SURESHBHAI	3 rd Mech. Engg.
BHATTACHARYA ABHI UTTAMKUMAR	3 rd Mech. Engg.
SHETHWALA JAIMIN VISHNUBHAI	3 rd Mech. Engg.
SUTHAR NIKHIL PINAKINBHAI	3 rd Mech. Engg.
PATEL HARSH PRAVINBHAI	3 rd Mech. Engg.
PATEL MILANKUMAR BHARATBHAI	3 rd Mech. Engg.
PATEL DHAVALKUMAR RAMESHBHAI	3 rd Mech. Engg.
PATEL VIRALKUMAR KANTILAL	3 rd Mech. Engg.
DARJI NIRAV NITINKUMAR	3 rd Mech. Engg.
PRAJAPATI JAY ASHOKKUMAR	3 rd Mech. Engg.
SOLANKI NIRMALKUMAR DHIRAJLAL	3 rd Mech. Engg.
PATEL JAYKUMAR VISNUBHAI	3 rd Mech. Engg.
UMANG CHAUHAN	3 rd Mech. Engg.
BHAVSAR ABHISHEK RAMESHKUMAR	5 th Mech. Engg.
PATEL DHAVALKUMAR ARVINDBHAI	5 th Mech. Engg.
PATEL BRIJESH CHANDRAKANTBHAI	5 th Mech. Engg.
PATEL NIKETKUMAR GAJENDRABHAI	5 th Mech. Engg.

PATEL RAVIKUMAR BHAGUBHAI	5 th Mech. Engg.
PATEL SUKETUKUMAR DAHYABHAI	5 th Mech. Engg.
PATEL SACHINKUMAR AMRUTLAL	5 th Mech. Engg.
RABARI BHARATKUMAR BABUBHAI	5 th Mech. Engg.
CHAUDHARI VIMALKUMAR BABUBHAI	5 th Mech. Engg.
PRAJAPATI AJAYKUMAR RAMJIBHAI	5 th Mech. Engg.
MODI JAIMINKUMAR BHADRESHKUMAR	5 th Mech. Engg.
ASODIYA ANANDKUMAR KISHORBHAI	5 th Mech. Engg.
SHAH CHIRAGKUMAR DHANJIBHAI	5 th Mech. Engg.
MERAIYA ASHUTOSH HIRALAL	5 th Mech. Engg.
PATEL PARTH DEVENDRABHAI	5 th Mech. Engg.
PATEL ASHISHKUMAR VISHNUBHAI	5 th Mech. Engg.
PATEL KISHAN HITENDRAKUMAR	5 th Mech. Engg.
PATEL VIMALKUMAR RAMESHBHAI	5 th Mech. Engg.
PATEL SUHAGKUMAR	5 th Mech. Engg.
PANDYA SAURABH NARENDRAKUMAR	5 th Mech. Engg.

Inaugurations



From Left to Right:

Prof. B D Patel (Co-coordinator), Mr. Utpal Patel (Expert), Mr. Jignesh Prajapati (Expert), Prof. J R Patel (Vice Principal), Prof. D A Patel (Head, MED), Prof. H B Patel (Head, CE/IT Deptt), Prof. D S Patel (Coordinator) & Prof. V A Patel (Senior Faculty, MED).

Inaugurations



During Workshop







Valedictory



Feed Back

Extent to which the purpose of Workshop was served

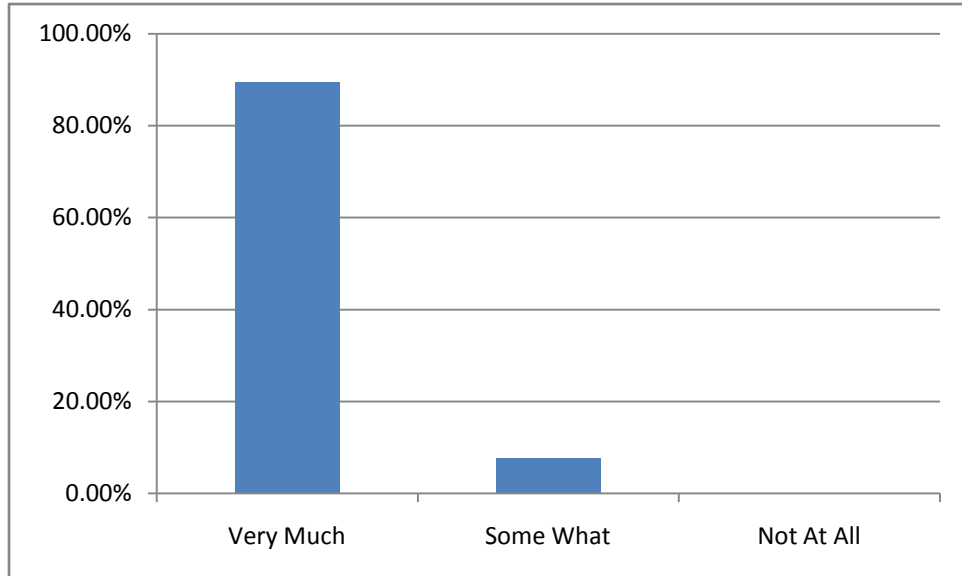

Organization of Session Contents

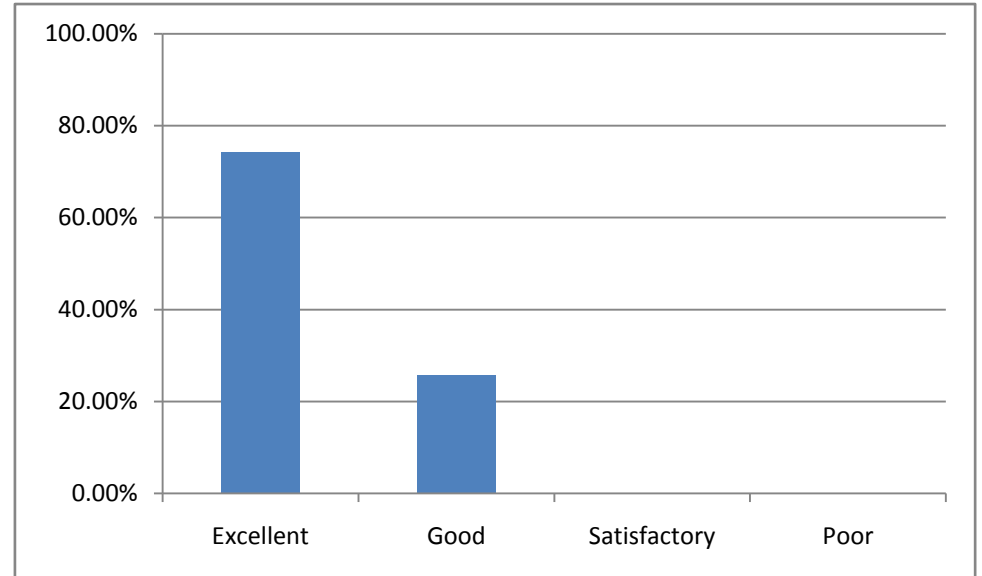

Quality of Presentation & structure of the talk

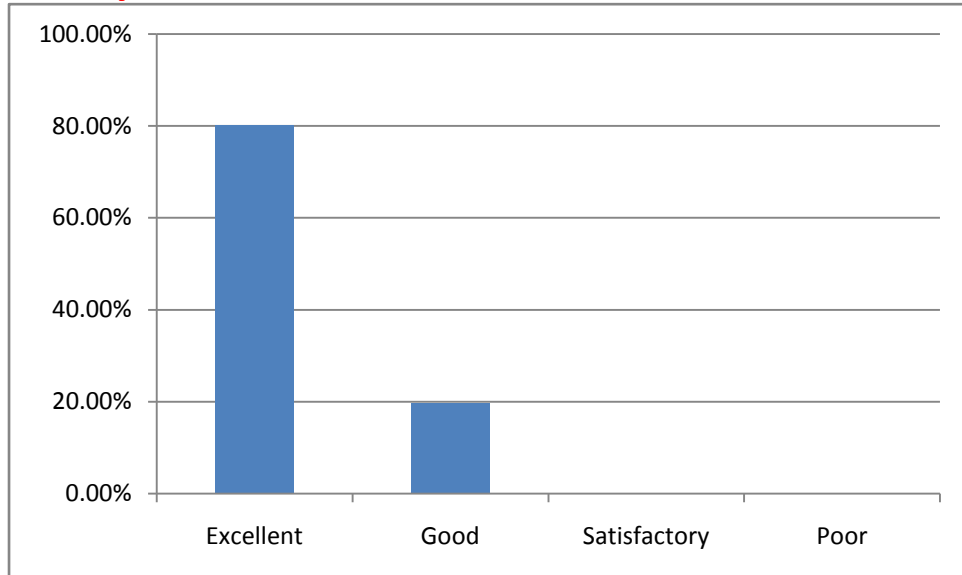

Flow of the program

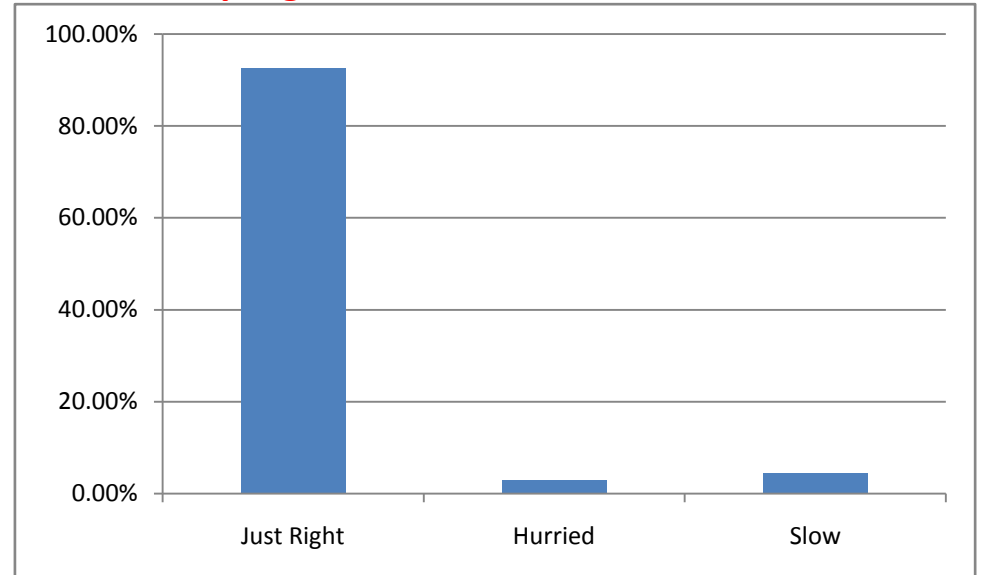

Effectiveness of Laboratory session

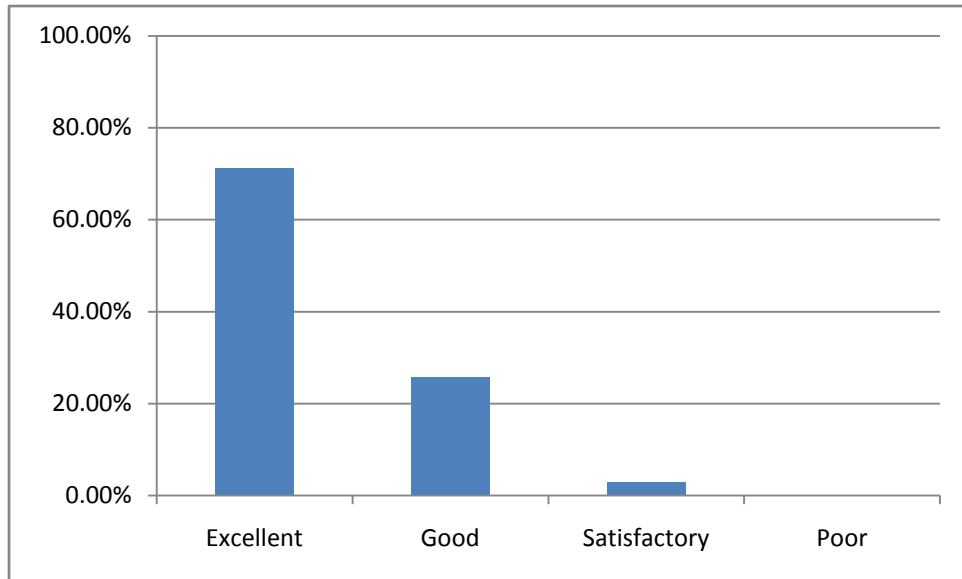

Location and facilities (Hall, Seating Arrangements, Amenities)

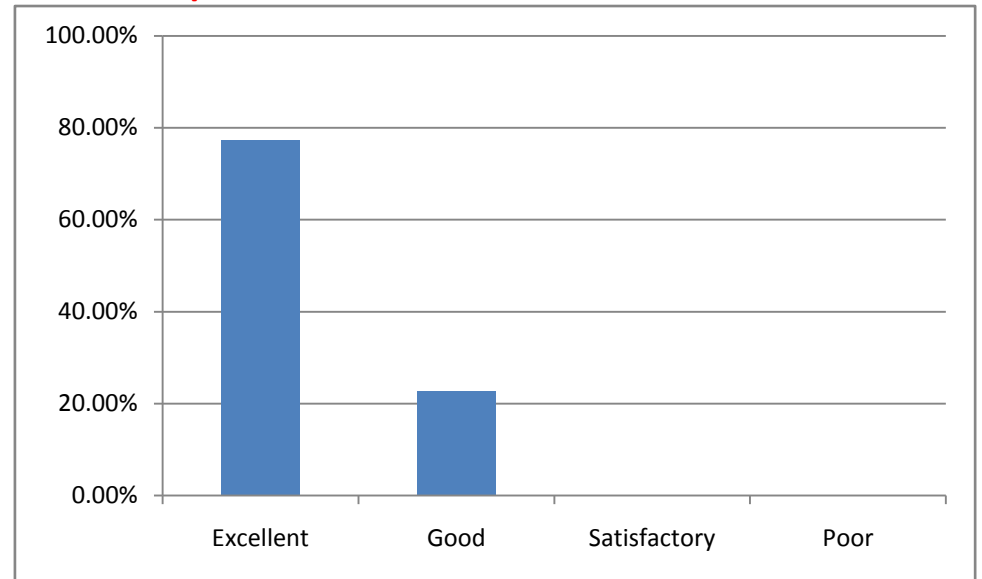

Overall Organization

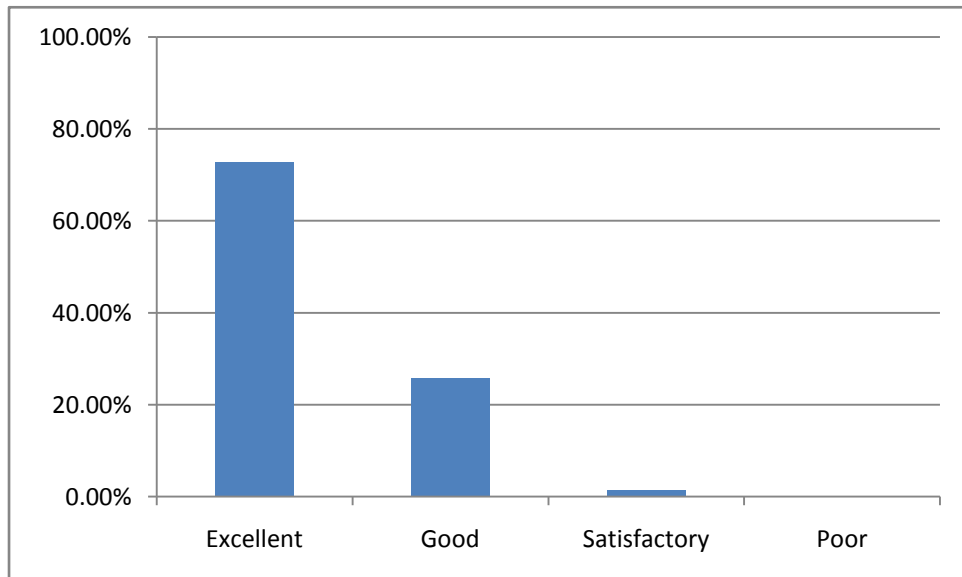

Would you participate in an event of this kind arranged by this institute/department?

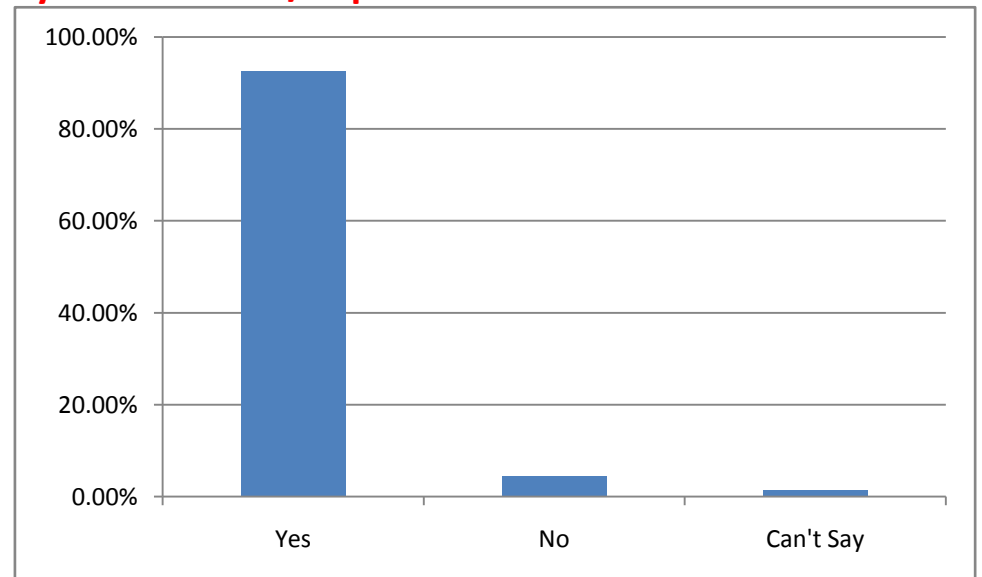

Group Photographs





Workshop Boucher

Three Days Workshop

On

Industrial Applications of Basic CAD

(on AutoCAD Software)

During

18th, 19th & 22nd September, 2012



Department of Mechanical Engineering
Sankalchand Patel College of Engineering
(A Unit of Nootan Sarva Vidhyalaya Kelavani Mandal)
Visnagar

Contents of the Course

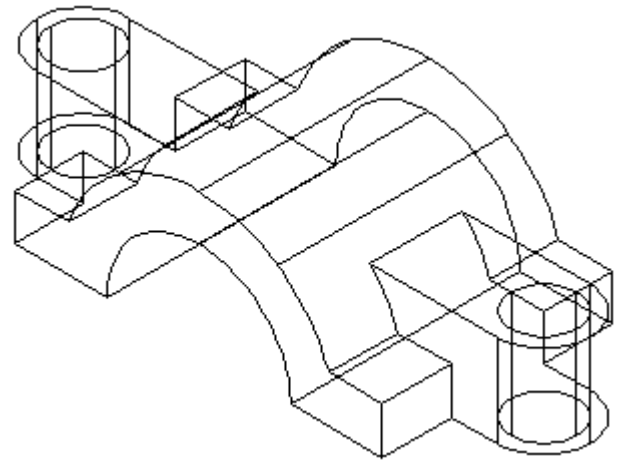
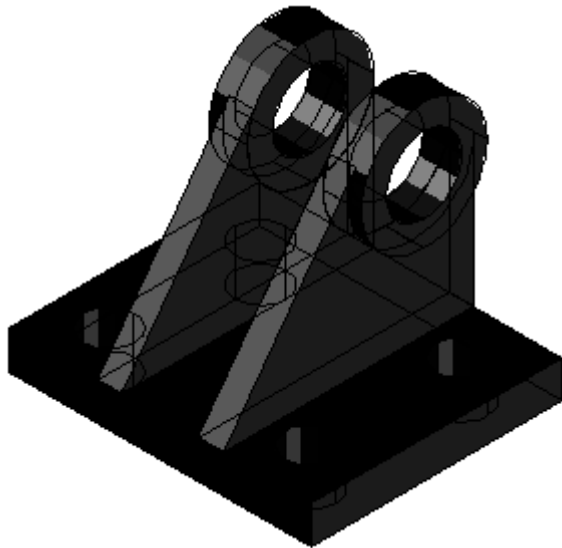

- Introduction of AutoCAD
- User Interface
- Basic Object Creation/ Modification
- Object Properties

- Dimensioning/Text/Hatch
- Patterns
- Plotting
- Layout

Experts

Mr. Jayesh Mehta,
AUTODESK Certified Instructor
(Advanced Design in AutoCAD)

Mr. Jignesh Prajapati,
AUTODESK Certified Instructor
(Advanced Design in AutoCAD)

Mr. Utpal Patel,
AUTODESK Certified Instructor
(Advanced Design in AutoCAD)

Registration Process

Duly signed completed registration form along with the course fees is to be submitted to the Coordinator on the address of communication mentioned beneath.

Last date of registration: 17-09-2012

Registration Fees : Rs. 200/- (Refundable for *SPCEans*)

: Rs. 1000/- (for others)

Coordinators

Prof. D S Patel (dspatel.mech@spcevng.ac.in) / Prof. B. D. Patel (bdpatel.mech@spcevng.ac.in)

Department of Mechanical Engineering,

Sankalchand Patel College of Engineering, Kamana Char Rasta, Visnagar – 384315

Phone No: +91 9909518275 / 9909468081

Fax No: +91 2765 224982

Prof D A Patel
(Head MED)

Dr. H. N. Shah
(Principal & Patron)

Shri B. C. Patel
(Chairman)

Form

Sankalchand Patel College of Engineering, Visnagar

Department of Mechanical Engineering

Organizes

Three Days Workshop

On

Industrial Applications of Basic CAD (on AutoCAD Software)

During

18th, 19th & 22nd September, 2012

APPLICATION FORM

Name _____

Enrollment No _____

Current Semester & Branch _____

Institute Name _____

Subject(s) of Your Interest _____

Email ID* _____

Contact No _____

Amount Paid** _____

Date:

Applicant Signature:

The information mentioned above is true to the best of my knowledge and the student is permitted to attend the workshop.

(Head of Department / Institute)

* The registration fee is refundable for the SPCEans upon successful completion of the workshop.

* Acceptance Notification and all other communications will be made through email only.

** Student will be offered tea only. Transportation and Accommodation are to be taken care of by the student only. CERTIFICATE will be issued upon successful participation in the workshop.

Address for Correspondence:

Prof. D S Patel (dspatel.mech@spcevng.ac.in) / Prof. B. D. Patel (bdpatel.mech@spcevng.ac.in)

Department of Mechanical Engineering,

Sankalchand Patel College of Engineering, Kamana Char Rasta, Visnagar – 384315

Phone No: +91 9909518275 / 9909468081

Fax No: +91 2765 224982